

Sales Code: ERQ8

Description: Ella Quadrant Enclosure 800X800mm

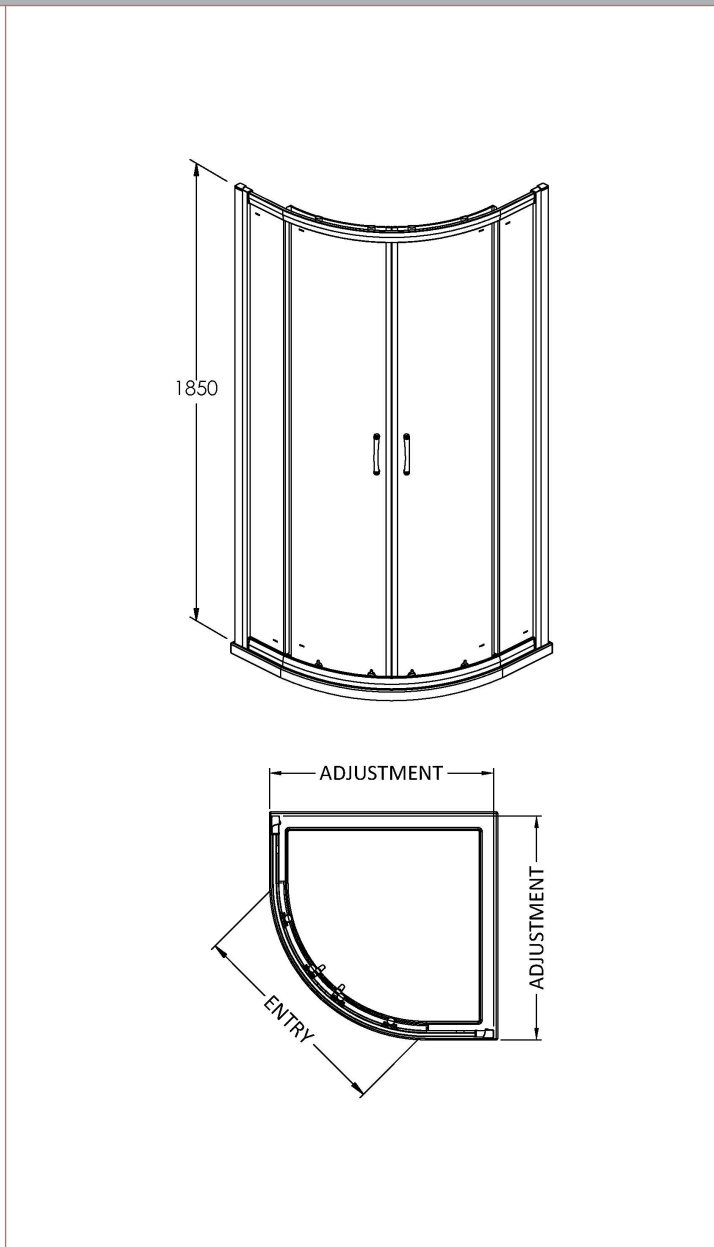

Product Dimensions	
Height (mm):	1850
Width (mm):	785
Depth (mm):	785
Nett Weight (kg):	33
Packaging Dimensions	
Height (mm):	1910
Width (mm):	410
Length (mm):	110
Gross Weight (kg):	33
Packaging Data	
Box Colour:	Brown Cardboard Box - Printed
Box Qty:	1
Label Size:	100 x 50
Label Colour:	Not Applicable
Label Qty:	0
Outer Box Dimensions (If Applicable)	
Height (mm):	
Width (mm):	
Depth (mm):	
Length (mm):	
Gross Weight (kg):	
Barcode:	5055369078592
Product Details	
Country of Origin:	China
Fitting Instruction:	No
CE & UKCA:	Yes
Profile Material:	Aluminium
Profile Finish:	Satin Chrome
Adjustments (mm):	765mm - 785mm
Entry Width (mm):	385mm
Swing In Dim (mm):	N/A
Swing Out Dim (mm):	N/A
Radius (mm):	538 mm
Glass Thickness (mm):	5
Easy Fit:	Yes
Easy Clean:	No
Handle Style:	D Shape Handle
Handle Material:	Plastic
Enclosure Design:	Framed
Wheel Type:	Plastic, Dual, Quick Release
Support Bar Included:	Support Bar Not Included
Extras:	None